

PSM01502

19" 3U 8TE

Made in Germany

150 Watts 2 outputs Power Supply Enclosed
184..265Vac Input, 0...+70°C

Short Specification:

- VME pin compatible
- 3U 19" Norm enclosed for 19" subracks
- Aluminium housing
- 89% efficiency typ.
- 0°C...+70°C full output power
- Free air convection
- Galvanic insulated
- Continuous short circuit protected
- Overload & low voltage protected
- Soft start & auto-recovery
- Hold up time >50ms
- Minimum load = 0A
- EMI/EMS EN61000-6-2,3, EN55022 class B
- cUL60950/16950 IEC(EN)60950-1
- H15M DIN41612 connector
- 24 hours burn in test
- High reliability, shock & vibration resistant

Special features:

- **Electric inrush current limiter**
- **Input voltage protection 8 KV**



AC-Input	184...265VAC, 47...63Hz , 250....300VDC (with 8000V/2.5KHz AC overload protection)			
Input Rating, Load	220...240VAC, 230VAC <1.5A			
Rated DC-Voltage	U1 +12V	U2 -12V	U1 +15V	U2 -15V
Rated Load	12.0A	12.0A	10.0A	10.0A
Max. Load	150W (24V/6.5A) boost 165W≤60sec		150W (30V/5.0A) boost 165W≤60sec	
Ripple [mVpp] ^{230Vac}	15 (20MHz)	15 (20MHz)	15 (20MHz)	15 (20MHz)

Tolerance	U1,U2 ± 0.5%
Stability at Load Switch 10-100%,	< ± 1.3% ±12V, ±0,2% 24..28V
Load Regulation	U1,U2 <1ms
Maximum Load	150W (boost 165W≤60sec)
Efficiency (in average over all outputs)	89% typ.
Overload Protection	1,1x P_{max} ,auto recovery
Over Voltage Protection	135% of U_{out} , auto recovery
Short Circuit Protection	Auto recovery
Temperature Control	Yes
Hold Up Time	> 50ms at 230Vac & rated load
Inrush Current	< 15A typ. (230Vac)
Softstart	20ms typ.
Cooling	Free air convection
Ambient Temp.	0°C...+70°C
Storage Temperature	- 40°C ...+85°C
EMI	EN55022 class B
EMS	EN61000-6-2,3
Safety	EN60950-1, EN60204-1
Safety class 1(A)	VDE0805, VDE0100
Air & Surface Leakage Paths	> 8mm
Input/Output	Galv. insulated
Minimum Load	0A
Pollution Degree	2 (EN50178)
Climatic Class	3k3 (EN60721)
Weight	720g
Connector	H15M DIN41612
Power Good (option)	Relay 48V/500mA max. load
MTBF at full load	450000h
Dimensions (HxWxD)	3U 8TE DIN41494, D=160mm

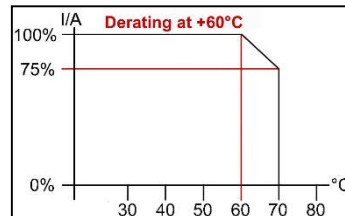

H15M DIN41612 connector (male)

- 32 = PE
- 30 = L
- 28 = N
- 26 = not used
- 24 = SD shut down
- 22 = U2 -
- 20 = U1/U2 GND
- 18 = U1 +
- 16 = not used
- 14 = not used
- 12 = not used
- 8,10 = not used
- 4,6 = relay (option)

Electric Inrush Current Limiter

Limitation between is always the same – independent from the ambient or the PSM device temperature.

Fuse

The PSM01502 has an electric short circuit protection. The fuse is a regular 5x20mm one and accessible from the outside.

AC-Input Overload Protection

The PSM01502 has an electric protection against AC stress peaks up to 8KV 2.5KHz.

Conception:

The Camtec PSM-Series provides you high efficiency by using a very small space in your rack system. Using the latest FET-technology leads to the most reliable system availability. The Camtec Overload Design guarantees state of the art reserves recommended. All devices are fixed so it can handle hard conditions of use on vehicles or military applications.

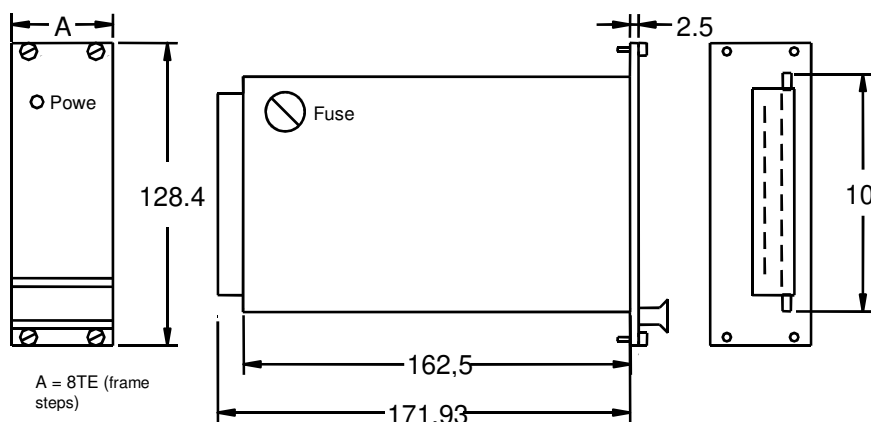

The 3U PSM Series is a high reliability AC power supply for universal use in electronics, automation systems, railway use and machinery building. Its compact design applies to low space applications. The regulated dc-voltage with ripple/noise of 15mVpp and a good efficiency of 89% is economic and is in accordance to EuP 2002/32/EC. We use high-end ultra longlife capacitors as a standard. The PSM power boost design starts critical loads at any time. The PSM internal function management controls illegal operating condition and prevents system break downs. For remote monitoring you can use the optional available galvanic insulated relay message contact. With the PSM series we used to emphasize on safety and interference resistance. The AC input verifies transient peaks up to 8000V (2.5KHz). The design is in accordance with EN60950 and complies with EN55022 class B.

Block Diagram

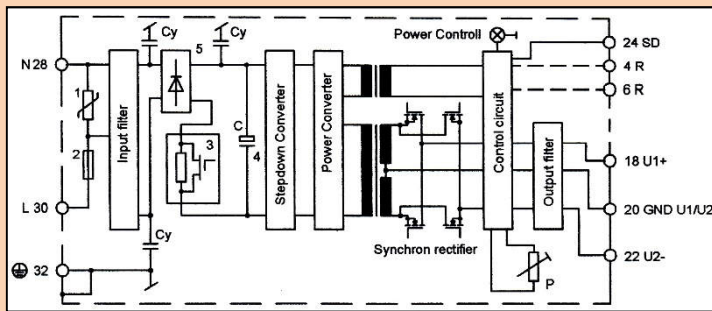

- 1) Transient suppressor (VDR)
 - 2) AC fuse
 - 3) Inrush Current Limiter
 - 4) Load Capacitor
 - 5) Rectifier
- P = trimmer poti (U1/U2 adjust is -3%...17% at 12V/24V and $\pm 3\%$ at 15/30V)

Sane filter technology uses 2 varistors, noise suppression chokes and X1 capacitors apply major transient resistance to the input filter. The synchron rectifier increases the efficiency of the PSM crucial. Compared to diode rectifying the power dissipation drops to a minimum. The emission is much lower to result in a longer lifetime of the PSM power supply.

Remote On/Off

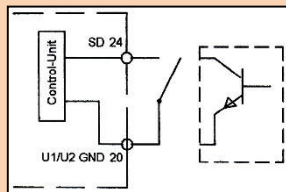

When the shut down input is not wired output voltage is available. If SD24 and GND is wired with a switch or open collector the PSM shuts down and the output voltage is disabled.

Output Combinations

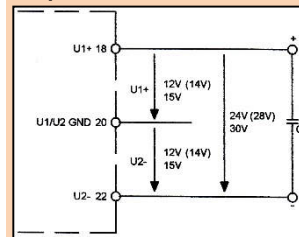

The PSM allows to configure different output voltages. The voltages can be adjusted with trimmer P. We advise to use a ceramic capacitor Co to reduce ripple and spikes. The power load can be distributed very flexible: no minimum load is required and the whole licit power can be taken from one single output, too.

Series Connection

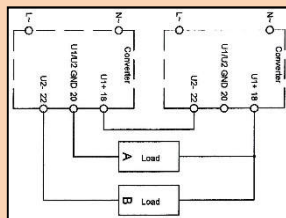

To increase the output power two equal PSM devices can be used connected.

Redundant Connection

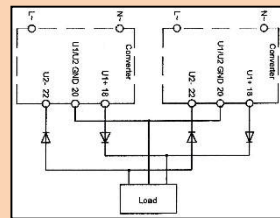

To increase system availability the PSM can be used in parallel operation mode. Please make sure that wiring length from both units to the load is equal.

Inrush Current Limitation (Block Diagram)

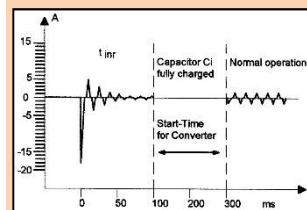
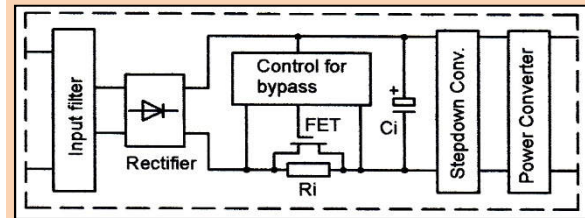

While connecting the PSM to the AC wire network its inrush current is limited to 15A (typ.). The start capacitors are loaded after 100ms and the PSM actuates. After passing softstart the power supply is ready for operation after a total of $t=300ms$.
Characteristics $V_i=230Vac$:
 Peak Inrush Current = 15A (typ.)
 Peak Limiting duration = 100ms

Order Codes:

APW01502.12.12	$\pm 12V$ output
APW01502.15.15	$\pm 15V$ output
APW01502.12.12.R	$\pm 12V$ output, relay
APW01502.15.15.R	$\pm 15V$ output, relay
APW01502.12.12.C	$\pm 12V$ output, coating
APW01502.15.15.C	$\pm 15V$ output, coating
APW01502.12.12.R.C	$\pm 12V$ output, relay & coating
APW01502.15.15.R.C	$\pm 15V$ output, relay & coating

DC o.k. Message (option)

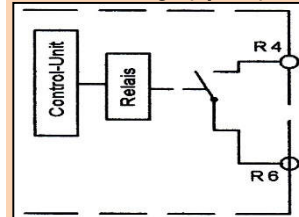

For remote monitoring you can use the optional available galvanic insulated relay message contact (Uout failure). The message is isolated and bears 48V/500mA maximum load.
 Vout o.k. = relay closed
 Vout fail = relay open

Optional Coating:

We offer the PSM-Series with optional coating. It is to be used in e.g. dusty, dirty, high humidity, or in awaiting quick temperature changes. Short circuit and corrosion at print board lines and at solder points can be prevented. The coat itself is a transparent acrylic resin. It is procured with a robotics varnishing machine.

Peters SL 1306 N-FLZ (transparent)
EN60216-1 2001
IPC-CC-830B
UL listed FileNo.: E80315 , UL94V-0

Safety Instructions:

Please read all warnings and advices carefully before installing or operating the PSM. Retain this operation manual always ready to hand. The PSM must be installed by specialist staff only.

Installation:

- 1.) The PSM is designed for systems fulfilling the safety norms of dangerous voltages/energy and fire prevention
- 2.) Installation is restricted to specialists only, make sure that the AC wire system is free of voltage
- 3.) Mounting to the rack system must be made with screws that have to be tool driven – power supply units are not allowed to be installed with milled screws
- 4.) The power supply has a fuse at the input AC-line (N wire). It is prohibited to change the fuse while the power supply is connected to the AC-line. We recommend changing the fuse to be made by our factory staff.

Warnings:

Disregard these warnings can cause fire, electric shock, serious accident and death.

1. **Attention: (N) Neutral-conductor -fuse**
2. **Never operate the PSM without Protective Earth Conductor**
3. **Before connecting the PSM to the AC wire system make all wires free of voltage and assure accidently switch on**
4. **Allow neat and professional cabling**
5. **Never open nor try to repair the PSM by yourself. Inside are dangerous voltages that can cause electric shock hazard.**
6. **Avoid metal pieces or other conductive material to fall into the PSM**
7. **Do not operate the PSM und damp or wet conditions**
8. **The PSM must not be operated under Ex conditions or in Ex-Area**

