

APW02202

Baseplate Cooled Made in Germany

150 Watts 2 Outputs Power Supply
184..265Vac Input, 0...+70°C, 8KV Burst
Active Inrush Current Limiter

Short Specification:

- VME pin compatible
- Aluminium housing
- 89% efficiency typ.
- 0°C...+70°C full output power
- Free air convection
- Galvanic insulated
- Continuous short circuit protected
- Overload & low voltage protected
- Soft start & auto-recovery
- Hold up time >50ms
- Minimum load = 0A
- EMI/EMS EN61000-6-2/3, EN55022 class B
- cUL60950/16950 IEC(EN)60950-1
- H15M DIN41612 connector
- 24 hours burn in test
- High reliability, shock & vibration resistant

Special features:

- Electric inrush current limiter
- Input voltage protection 8 KV

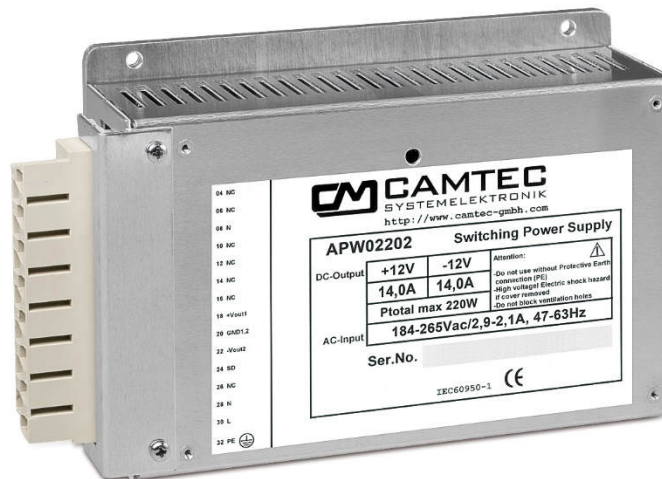

AC Input Range	184...265Vac, 47...63Hz , 250....300Vdc (8KV/2.5KHz OVP on AC stress peaks)					
AC Input Rated	220...240Vac, 230Vac <1.5A					
Model (recommended)	APW02202.12.12			APW02202.15.15		
Model with Coating	APW02202.12.12C			APW02202.15.15C		
DC Output Voltage	+12V (U1)	-12V (U2)	+24V (U3)	+15V (U1)	-15V (U2)	+30V (U3)
DC Current (max.)	12.0A	12.0A	9,2A	10.0A	10.0A	7,3A
Ripple [230Vac, 20MHz]	15mVss	15mVss	30mVss	15mVss	15mVss	30mVss
Rated Power	220W balance of operations					
Vout U1/U2 adj.range	See info p.3					

Tolerance	U1,U2 ± 0.5%
Stability at Load Switch 10-100%,	< ± 1.3% ±12V, ±0,2% 24..28V
Load Regulation	U1,U2 <1ms
Maximum Load	220W (boost 242W ≤ 60sec)
Efficiency (in average over all outputs)	typ. 91%
Overload Protection	1,1x P _{max} ,auto recovery
Over Voltage Protection	135% of U _{out} , auto recovery
Short Circuit Protection	Auto recovery
Temperature Control	Yes
Hold Up Time	> 50ms at 230Vac & rated load
Inrush Current	< 15A typ. (230Vac)
Softstart	20ms typ.
Cooling	Free air convection
Ambient Temp.	0°C ...+70°C
Storage Temperature	- 40°C ...+85°C
EMI	EN55022 class B
EMS	EN61000-6-2,3
Safety	EN60950-1, EN60204-1
Safety class 1(A)	VDE0805, VDE0100
Air & Surface Leakage Paths	> 8mm
Input/Output	Galv. Insulated 3KV
Minimum Load	0A
Pollution Degree	2 (EN50178)
Climatic Class	3k3 (EN60721)
Weight	950g
Connector	H15M DIN41612
Power Good (option)	Relay 48V/500mA max. load
MTBF at full load	450000h
MTTF EN61709, SN29500	178.312h (40°C 75%)
Dimensions (HxWxD) (arbitrary back plane)	126x61x177mm (wide back plane) 101x61x177mm (small back plane)

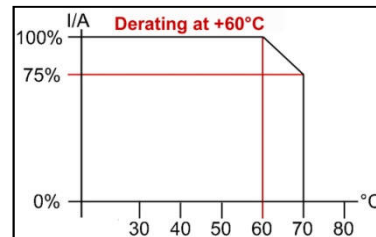

H15M DIN41612 connector (male)

- 32 = PE
- 30 = L
- 28 = N
- 26 = not used
- 24 = SD shut down
- 22 = U2 -
- 20 = U1/U2 GND
- 18 = U1 +
- 12,14,16 = not used
- 4, 6, 8,10 = not used



Left poti to adjust U1 to U3.
Do not use the right poti!

The **APW02202** is a high reliability AC power supply for special use in electronics, automation systems, railway use and machinery building. **It is designed for applications where controlled heat distribution is a must.** The inner design of the **APW02202** allows power loss heat to be distributed directly to its cooling plate, and then to be transferred directly out of the system when mounting it to a metal wall. Its compact design applies to low space applications. The regulated dc-voltage with ripple/noise of 15mVpp and a good efficiency of 91% is economic and is in accordance to EuP 2002/32/EC. We use high-end ultra longlife capacitors as a standard. The APW power boost design starts critical loads at any time. The APW internal function management controls illegal operating condition and prevents system break downs. For remote monitoring you can use the optional available galvanic insulated relay message contact. With the APW series we used to emphasize on safety and interference resistance. The AC input verifies transient peaks up to 8000V (2.5KHz). The design is in accordance with EN60950 and complies with EN55022 class B.

Block Diagram

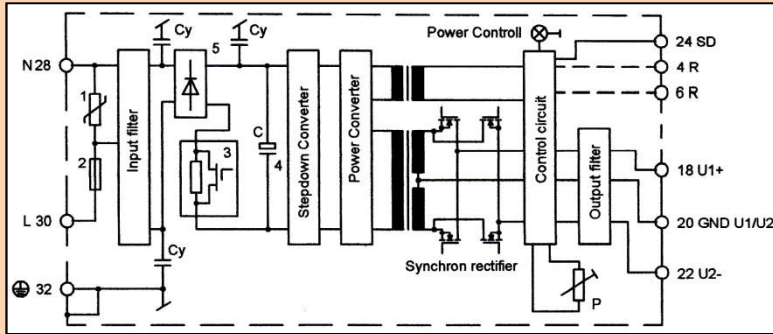

- 1) Transient suppressor (VDR)
 - 2) AC fuse
 - 3) Inrush Current Limiter
 - 4) Load Capacitor
 - 5) Rectifier
- P = trimmer poti (U1/U2 adjust is -3%...17% at 12V/24V and $\pm 3\%$ at 15/30V)

Sane filter technology uses 2 varistors, noise suppression chokes and X1 capacitors apply major transient resistance to the input filter. The synchron rectifier increases the efficiency of the APW crucial. Compared to diode rectifying the power dissipation drops to a minimum. The emission is much lower to result in a longer lifetime of the APW power supply.

Remote On/Off

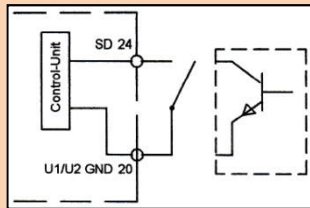

When the shut down input is not wired output voltage is available. If SD24 and GND is wired with a switch or open collector the APW shuts down and the output voltage is disabled.

Output Combinations

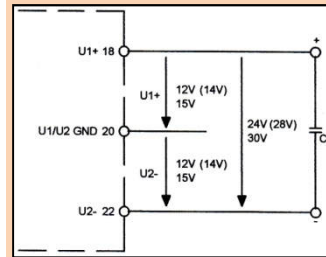

The APW allows to configure different output voltages. The voltages can be adjusted with trimmer P. We advise to use a ceramic capacitor C_o to reduce ripple and spikes. The power load can be distributed very flexible: no minimum load is required and the whole licit power can be taken from one single output, too.

Series Connection

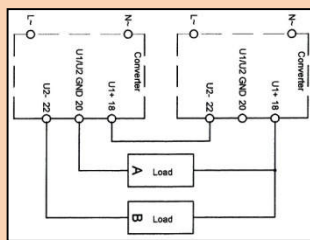

To increase the output power two equal APW devices can be used connected.

Redundant Connection

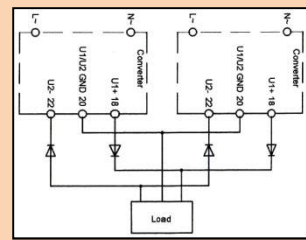

To increase system availability the APW can be used in parallel operation mode. Please make sure that wiring length from both units to the load is equal.

Inrush Current Limitation (Block Diagram)

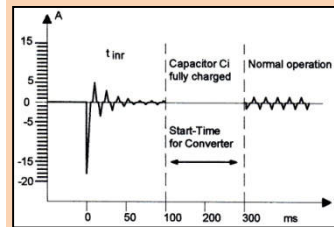
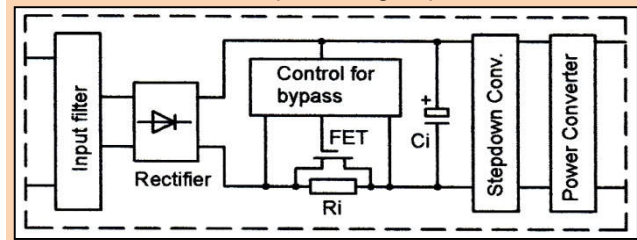

While connecting the APW to the AC wire network its inrush current is limited to 15A (typ.). The start capacitors are loaded after 100ms and the APW actuates. After passing softstart the power supply is ready for operation after a total of $t=300ms$.
Characteristics $V_i=230Vac$:
 Peak Inrush Current = 15A (typ.)
 Peak Limiting duration = 100ms

DC o.k. Message (option)

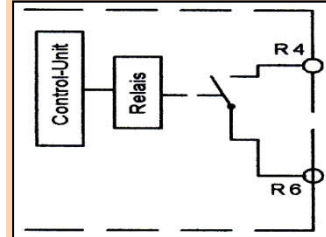

For remote monitoring you can use the optional available galvanic insulated relay message contact (Uout failure). The message is isolated and bears 48V/500mA maximum load.
 Vout o.k. = relay closed
 Vout fail = relay open

Optional Coating:

We offer the APW-Series with optional coating. It is to be used in e.g. dusty, dirty, high humidity, or in awaiting quick temperature changes. Short circuit and corrosion at print board lines and at solder points can be prevented. The coat itself is a transparent acrylic resin. It is procured with a robotics varnishing machine.

Peters SL 1306 N-FLZ (transparent)

EN60216-1 2001

IPC-CC-830B

UL listed FileNo.: E80315 , UL94V-0

Order Codes:

APW02202.12.12H ±12V output
 APW02202.15.15H ±15V output

Options to be added to the order-code:

C coating

Cooling Base Plate

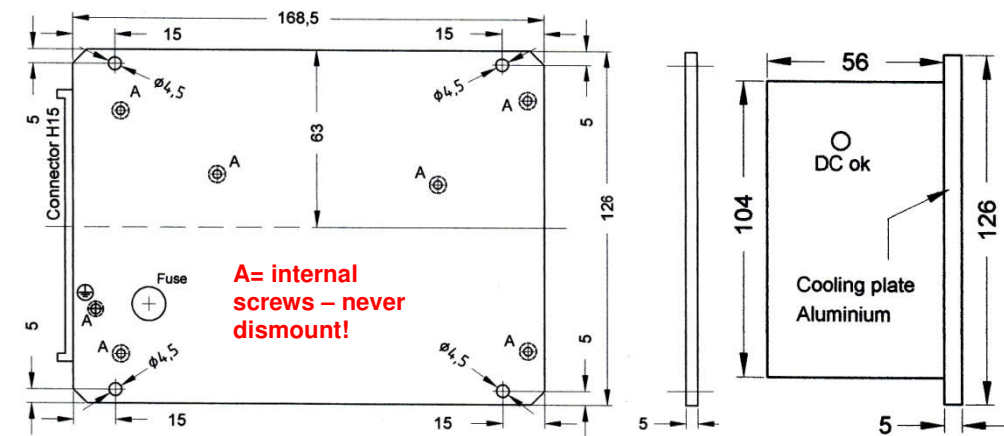

Fix the APW with M4 screws on a planar face to your system. Never dismount GND-screws from the power supply.

H15M connector

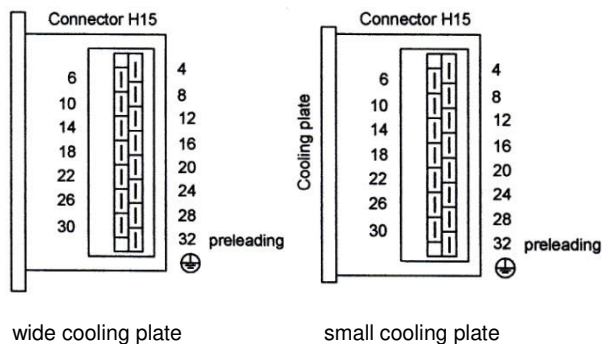

H15M connector fastening bracket

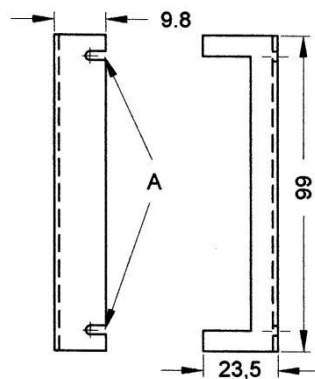

This fastening bracket prevents the H15M connector from accidental disconnect. Mounting screws A M2.5x5mm are to be used.

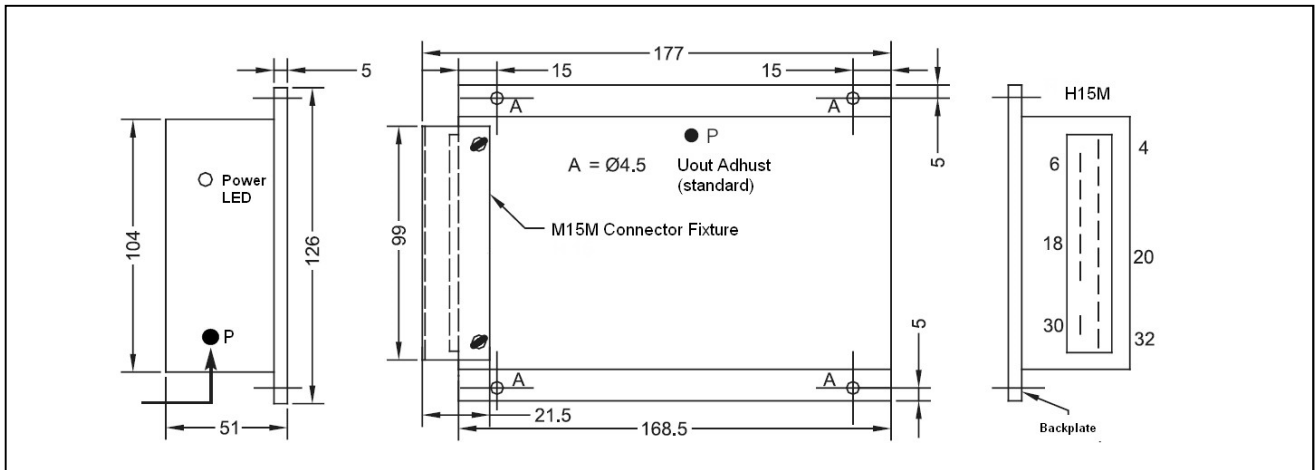

Safety Instructions:

Please read all warnings and advices carefully before installing or operating the APW. Retain this operation manual always ready to hand. The APW must be installed by specialist staff only.

Installation:

- 1.) The APW is designed for systems fulfilling the safety norms of dangerous voltages/energy and fire prevention
- 2.) Installation is restricted to specialists only, make sure that the AC wire system is free of voltage
- 3.) Mounting to the rack system must be made with screws that have to be tool-driven – power supply units are not allowed to be installed with milled screws
- 4.) The power supply has a fuse at the input AC-line (N wire). It is prohibited to change the fuse while the power supply is connected to the AC-line. We recommend changing the fuse to be made by our factory staff.

Warnings:

Disregard these warnings can cause fire, electric shock, serious accident and death.

1. **Attention: (N) Neutral-conductor -fuse**
2. **Never operate the APW without Protective Earth Conductor**
3. **Before connecting the APW to the AC wire system make all wires free of voltage and assure accidentally switch on**
4. **Allow neat and professional cabling**
5. **Never open nor try to repair the APW by yourself. Inside are dangerous voltages that can cause electric shock hazard.**
6. **Avoid metal pieces or other conductive material to fall into the APW**
7. **Do not operate the APW und damp or wet conditions**
8. **The APW must not be operated under Ex conditions or in Ex-Area**



All parameters base on 15 minutes run-in @ full load / 25°C / 230Vac 50/60Hz, as otherwise stated.